



BWA - WASHINGTON LIGHTING BOLLARD

LIGHTING BOLLARDS

C O N C R E T E B O L L A R D S



UTILITY STRUCTURES INC.

THE HAMPTON LIGHTING BOLLARD



BHA-042-3-AJ-AR-HPS-120V

TYPICAL BOLLARD DETAIL

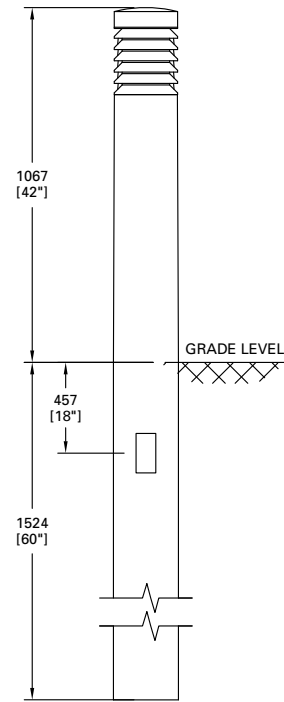

INSTALLATION OPTIONS

Direct buried is standard.

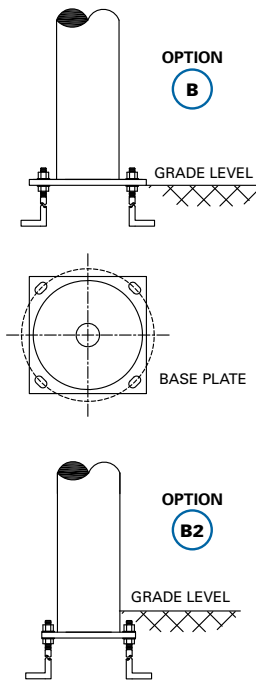

CAP DETAIL

Concrete cap is standard.

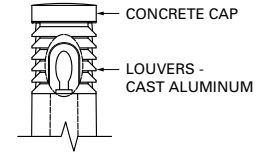

CAP DETAIL (OPTION)

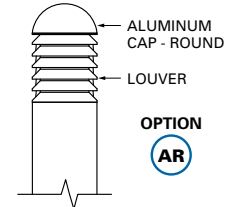

CAP DETAIL (OPTION)

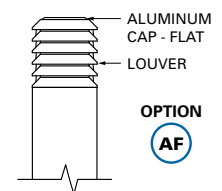

EXAMPLE OF TYPICAL CATALOG NUMBER

Select options as required.

BHA - **042** - **3** - **AJ** - **B** - **S1**

BOLLARD STYLE
Hampton Bollard

ABOVE GRADE
(inches) 42"

FINISH
Etched

COLOUR
Aztec Jade

OPTION
Base Plate - Flush with Bolt Exposed

OPTION
Base Shroud - Round

Select OPTIONS

The Hampton bollard has 6 standard options to choose from.

CODE	DESCRIPTION
B	Base Plate - Flush with Bolts Exposed
B2	Base Plate - Below Grade Stub
AR	Aluminum Cap - Round
AF	Aluminum Cap - Flat
R	GFI Receptacle
S1	Base Shroud - Round

LAMPING OPTIONS

CODE	DESCRIPTION
HPS	High Pressure Sodium
MH	Metal Halide
LED	LED

ELECTRICAL OPTIONS

CODE	DESCRIPTION
120V	120 volts
277V	277 volts
347V	347 volts

Note: Consult USI for additional voltages.

Select BOLLARD STYLE

USI concrete bollards are available in 4 different styles.

CODE	DESCRIPTION
BHA	Hampton Bollard
BMA	Madison Bollard
BST	Stratford Bollard
BWA	Washington Bollard

Select SURFACE FINISH

USI concrete bollards are available with 2 types of surface finishes.

CODE	DESCRIPTION
N/A	Polished finish
3	Etched finish
4	Exposed finish

Select COLOUR

Our bollards are available in all 12 colours. Please visit our Colours & Finishes section for complete information.

CODE	DESCRIPTION
AJ	Aztec Jade
BE	Black Eclipse
DB	Dark Bronze
SP	Salt & Pepper



61 BONGARD AVENUE, OTTAWA, ONTARIO CANADA K2E 6V2
 TEL: [613] 225-6398 • FAX: [613] 225-1681 • TOLL FREE: 1-800-267-6466
 www.utilitystructures.com



THE MADISON LIGHTING BOLLARD



BMA-042-2-DB-AR-MH-277V

TYPICAL BOLLARD DETAIL

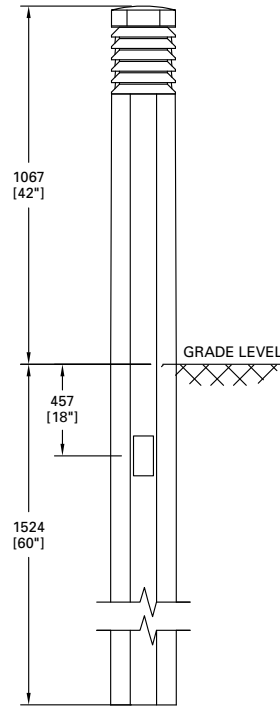

INSTALLATION OPTIONS

Direct buried is standard.

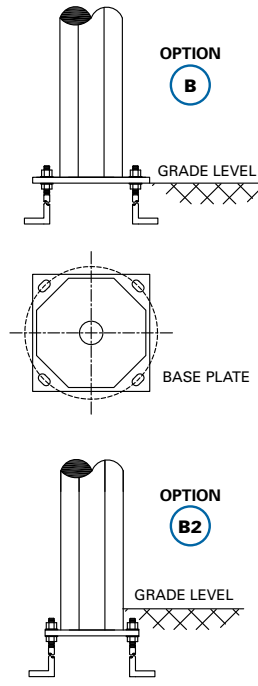

CAP DETAIL

Concrete cap is standard.

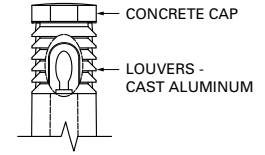

CAP DETAIL (OPTION)

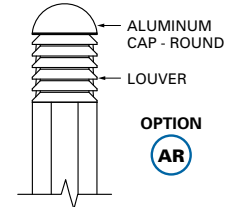

CAP DETAIL (OPTION)

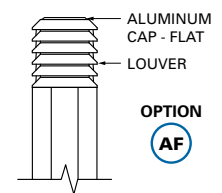

EXAMPLE OF TYPICAL CATALOG NUMBER

Select options as required.

BMA - **042** - **2** - **DB** - **B** - **AR**

BOLLARD STYLE
Madison Bollard

ABOVE GRADE
(inches) 42"

FINISH
Polished

COLOUR
Dark Bronze

OPTION
Base Plate - Flush with Bolt Exposed

OPTION
Aluminum Cap - Round

Select OPTIONS

The Madison bollard has 6 standard options to choose from.

CODE	DESCRIPTION
B	Base Plate - Flush with Bolts Exposed
B2	Base Plate - Below Grade Stub
AR	Aluminum Cap - Round
AF	Aluminum Cap - Flat
R	GFI Receptacle
S1	Base Shroud - Round

Select BOLLARD STYLE

USI concrete bollards are available in 4 different styles.

CODE	DESCRIPTION
BHA	Hampton Bollard
BMA	Madison Bollard
BST	Stratford Bollard
BWA	Washington Bollard

Select SURFACE FINISH

USI concrete bollards are available with 3 types of surface finishes.

CODE	DESCRIPTION
2	Polished finish
3	Etched finish
4	Exposed finish

Select COLOUR

Our bollards are available in all 12 colours. Please visit our Colours & Finishes section for complete information.

CODE	DESCRIPTION
AJ	Aztec Jade
BE	Black Eclipse
DB	Dark Bronze
SP	Salt & Pepper

LAMPING OPTIONS

CODE	DESCRIPTION
HPS	High Pressure Sodium
MH	Metal Halide
LED	LED

ELECTRICAL OPTIONS

CODE	DESCRIPTION
120V	120 volts
277V	277 volts
347V	347 volts

Note: Consult USI for additional voltages.



61 BONGARD AVENUE, OTTAWA, ONTARIO CANADA K2E 6V2
TEL: [613] 225-6398 • FAX: [613] 225-1681 • TOLL FREE: 1-800-267-6466
www.utilitystructures.com



THE STRATFORD LIGHTING BOLLARD



BST-042-2-AJ-MH-120V

TYPICAL BOLLARD DETAIL

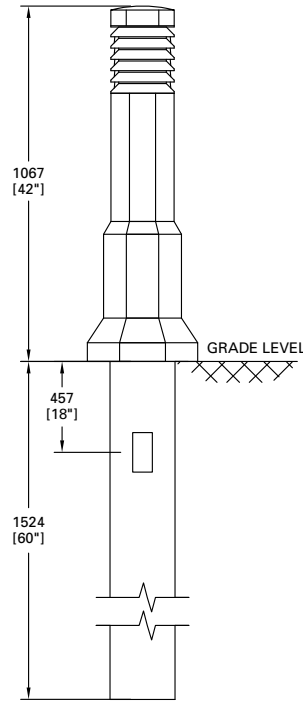

INSTALLATION OPTIONS

Direct buried is standard.

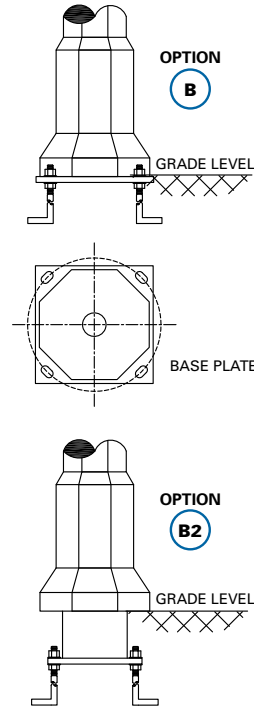

CAP DETAIL

Concrete cap is standard.

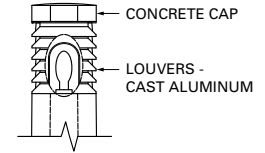

CAP DETAIL (OPTION)

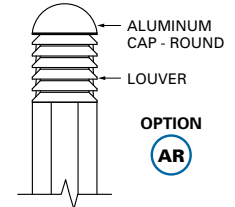

CAP DETAIL (OPTION)

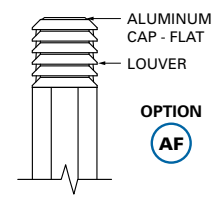

EXAMPLE OF TYPICAL CATALOG NUMBER

Select options as required.

BST - **042** - **2** - **AJ** - **B** - **AR**

BOLLARD STYLE
Stratford Bollard

ABOVE GRADE
(inches) 42"

FINISH
Polished

COLOUR
Aztec Jade

OPTION
Base Plate - Flush with Bolt Exposed

OPTION
Aluminum Cap - Round

Select OPTIONS

The Stratford bollard has 5 standard options to choose from.

CODE	DESCRIPTION
B	Base Plate - Flush with Bolts Exposed
B2	Base Plate - Below Grade Stub
AR	Aluminum Cap - Round
AF	Aluminum Cap - Flat
R	GFI Receptacle

Select BOLLARD STYLE

USI concrete bollards are available in 4 different styles.

CODE	DESCRIPTION
BHA	Hampton Bollard
BMA	Madison Bollard
BST	Stratford Bollard
BWA	Washington Bollard

Select SURFACE FINISH

USI concrete bollards are available with 3 types of surface finishes.

CODE	DESCRIPTION
2	Polished finish
3	Etched finish
4	Exposed finish

Select COLOUR

Our bollards are available in all 12 colours. Please visit our Colours & Finishes section for complete information.

CODE	DESCRIPTION
AJ	Aztec Jade
BE	Black Eclipse
DB	Dark Bronze
SP	Salt & Pepper

LAMPING OPTIONS

CODE	DESCRIPTION
HPS	High Pressure Sodium
MH	Metal Halide
LED	LED

ELECTRICAL OPTIONS

CODE	DESCRIPTION
120V	120 volts
277V	277 volts
347V	347 volts

Note: Consult USI for additional voltages.



61 BONGARD AVENUE, OTTAWA, ONTARIO CANADA K2E 6V2
TEL: [613] 225-6398 • FAX: [613] 225-1681 • TOLL FREE: 1-800-267-6466
www.utilitystructures.com



THE WASHINGTON LIGHTING BOLLARD



BWA-042-3-BE-LED

TYPICAL BOLLARD DETAIL

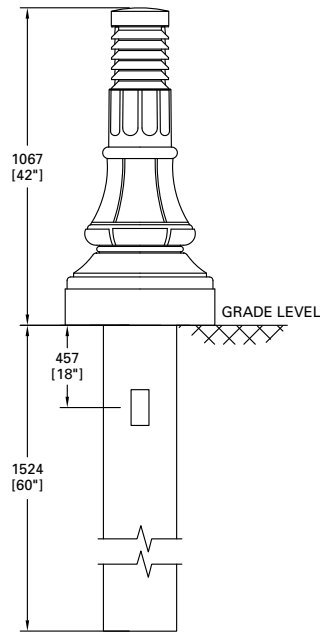

INSTALLATION OPTIONS

Direct buried is standard.

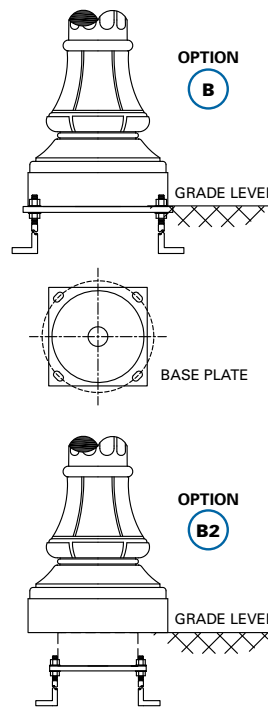

CAP DETAIL

Concrete cap is standard.

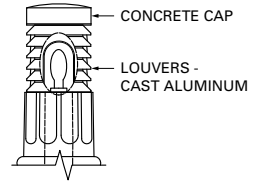

CAP DETAIL (OPTION)

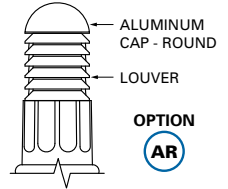

CAP DETAIL (OPTION)

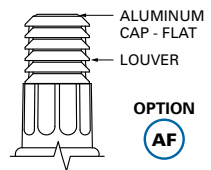

EXAMPLE OF TYPICAL CATALOG NUMBER

Select options as required.



Select OPTIONS

The Washington bollard has 5 standard options to choose from.

CODE	DESCRIPTION
B	Base Plate - Flush with Bolts Exposed
B2	Base Plate - Below Grade Stub
AR	Aluminum Cap - Round
AF	Aluminum Cap - Flat
R	GFI Receptacle

Select BOLLARD STYLE

USI concrete bollards are available in 4 different styles.

CODE	DESCRIPTION
BHA	Hampton Bollard
BMA	Madison Bollard
BST	Stratford Bollard
BWA	Washington Bollard

Select SURFACE FINISH

USI concrete bollards are available with 2 types of surface finishes.

CODE	DESCRIPTION
N/A	Polished finish
3	Etched finish
4	Exposed finish

Select COLOUR

Our bollards are available in all 12 colours. Please visit our Colours & Finishes section for complete information.

CODE	DESCRIPTION
AJ	Aztec Jade
BE	Black Eclipse
DB	Dark Bronze
SP	Salt & Pepper

LAMPING OPTIONS

CODE	DESCRIPTION
HPS	High Pressure Sodium
MH	Metal Halide
LED	LED

ELECTRICAL OPTIONS

CODE	DESCRIPTION
120V	120 volts
277V	277 volts
347V	347 volts

Note: Consult USI for additional voltages.



61 BONGARD AVENUE, OTTAWA, ONTARIO CANADA K2E 6V2
 TEL: [613] 225-6398 • FAX: [613] 225-1681 • TOLL FREE: 1-800-267-6466
 www.utilitystructures.com



BHA - HAMPTON LIGHTING BOLLARD



BMA - MADISON LIGHTING BOLLARD



BHA - HAMPTON LIGHTING BOLLARD

USI LIGHTING BOLLARDS

Our decorative bollards facilitate traffic control and can complement the aesthetics of almost any landscape.

- Available in a variety of cross sections.
- Available in direct buried or base mounted.
- Available in a variety of colours and finishes.
- Applications include security and architectural uses.
- Will accept a variety of luminaire mounting styles.



BST - SRATFORD LIGHTING BOLLARD



BHA - HAMPTON LIGHTING BOLLARD

LIGHTING BOLLARDS

CONCRETE BOLLARDS



UTILITY STRUCTURES INC.

61 BONGARD AVENUE, OTTAWA, ONTARIO CANADA K2E 6V2

TEL: [613] 225-6398 • FAX: [613] 225-1681 • TOLL FREE: 1-800-267-6466

www.utilitystructures.com