

# CA

# THE CAMBRIDGE SERIES

## TYPICAL POLE DETAIL

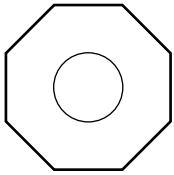





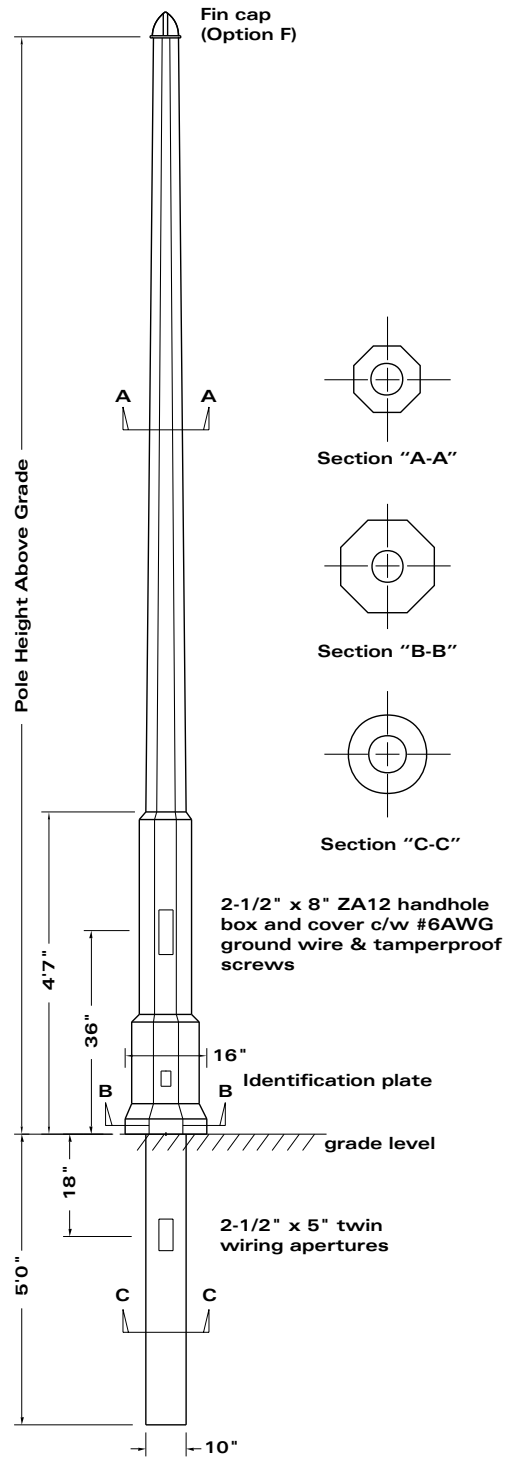



### CROSS SECTION



OCTAGONAL



PLEASE FILL IN CODE

|   |   |   |   |   |   |   |   |   |   |   |   |  |   |   |   |   |   |   |
|---|---|---|---|---|---|---|---|---|---|---|---|--|---|---|---|---|---|---|
|  | - |  | - |  | - |  | - |  | - |  | - |  | - |  | - |  | - |  |
| POLE STYLE  |   | OVERALL HEIGHT  |   | CLASS   |   | FINISH  |   | COLOUR  |   | FIXTURE MOUNT   |   | OPTION   |   | OPTION  |   | OPTION  |   | OPTION  |

Select options as required



61 BONGARD AVENUE, OTTAWA, ONTARIO CANADA K2E 6V2  
 TEL: [613] 225-6398 • FAX: [613] 225-1681 • TOLL FREE: 1-800-267-6466  
 www.utilitystructures.com