

ST

THE STRATFORD SERIES

TYPICAL POLE DETAIL

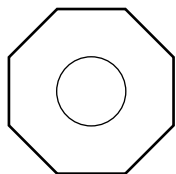





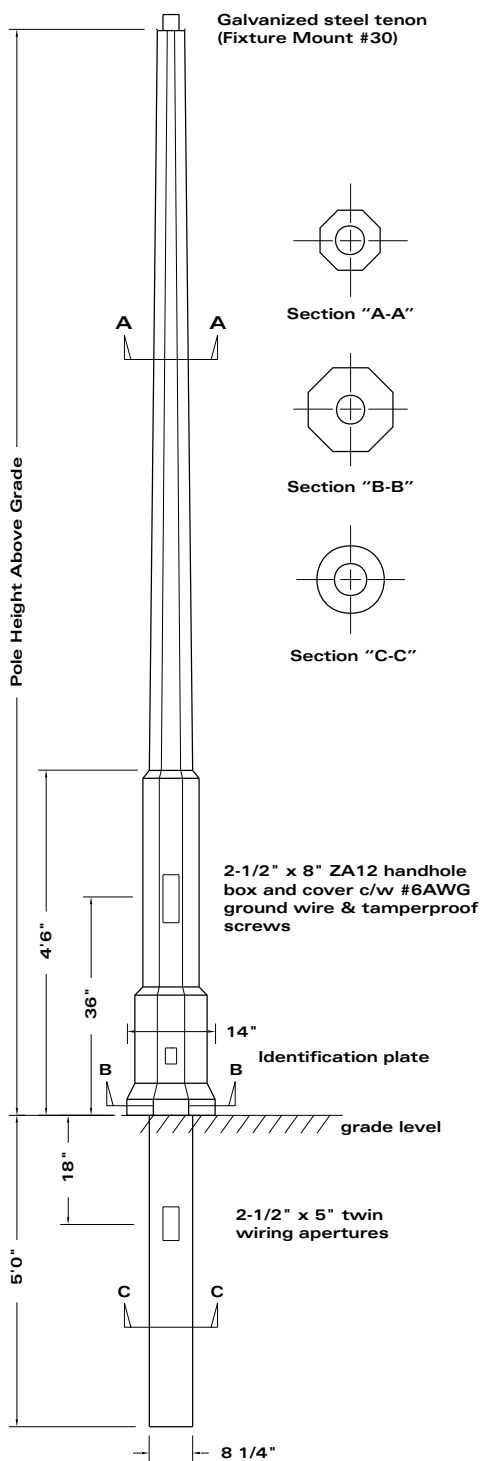



CROSS SECTION



OCTAGONAL



PLEASE FILL IN CODE

	-		-		-		-		-		-		-		-		-	
POLE STYLE		OVERALL HEIGHT		CLASS		FINISH		COLOUR		FIXTURE MOUNT		OPTION		OPTION		OPTION		OPTION

Select options as required



61 BONGARD AVENUE, OTTAWA, ONTARIO CANADA K2E 6V2
TEL: [613] 225-6398 • FAX: [613] 225-1681 • TOLL FREE: 1-800-267-6466
www.utilitystructures.com